

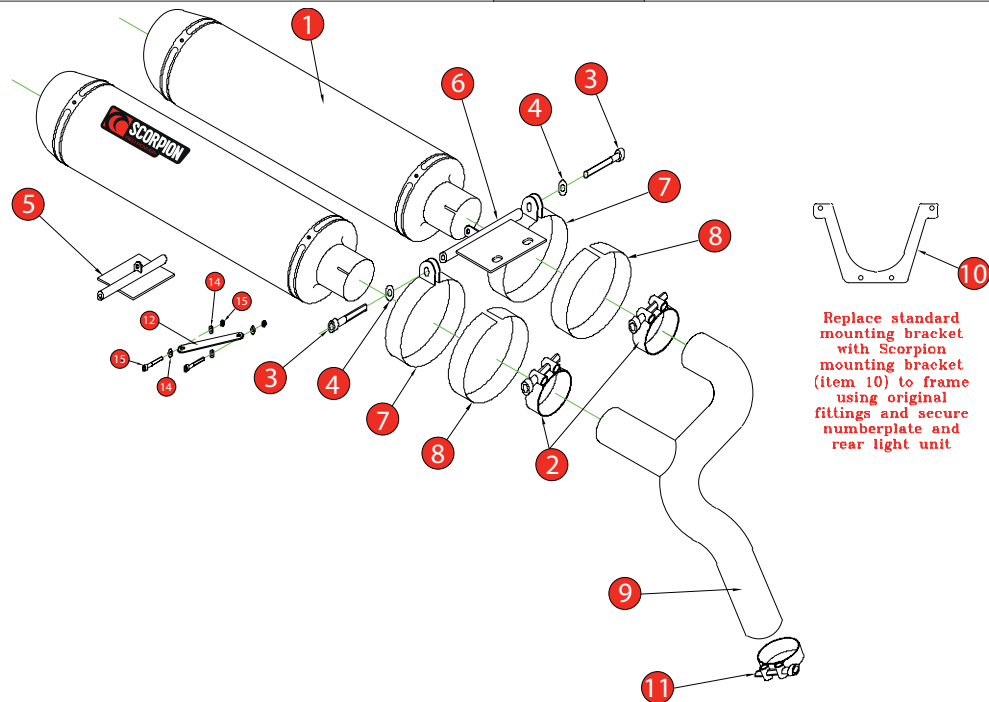



BIKE	Yamaha FZ6 / FZS600 Fazer	PART NO.	EYA - 70
YEAR	2004-06	FIT KITS	OVAL Z039.11118 / ROUND Z039.10118
NOTES	Use standard fittings where not supplied <b>Remove standard gasket if fitted.</b>	DB-Killer	2 x SCEXDBK12 - (Type B)



1	2 x 250mm Silencers ESC 70	10	Number Plate Brk't (Z015.10028)
2	2 x 51 - 55mm Band Clamps (Z016.10002)	11	47-51mm Band Clamp (Z016.10003)
3	2 x M8 x 20mm Cap Head Bolts (Z017.10072)	12	Brace Arm (Z007.11002)
4	2 x M8 x 25mm Washers (Z017.10825)	13	2 x M6 x 15mm Cap Head Bolts(Z017.10609)
5	Underseat Mounting Brk't (Z026.20020)	14	4 x M6 x 17mm Washers (Z017.12722)
6	Strap Bracket (Z026.20021)	15	2 x M6 Nyloc Nuts (Z017.10033)
7	2 x Silencer Straps (R-Z028.10229)(O-Z028.10266)	16	Photo Fitting Instructions
8	2 x Protective Rubber Straps (Z029.10022)		
9	Connecting Pipe CP 218 (Z035.10218)		

E-MARK ROUND	SC70R  2124 
E-MARK OVAL	SC70O  2125 
ISSUE NO.	16
DATE	22/10/2018
AUTHORISED	J.Harkin
CHECKED	

**NOTE:** ENSURE SCORPION SYSTEM IS CLEAR OF MOVING PARTS AND ALL ORIGINAL FUNCTIONS WORK CORRECTLY.



Box: PLOCK 2

BIKE	Yamaha FZ6 / FZS600 Fazer	PART NO.	EYA-70
YEAR	2004-06	FIT KITS	OVAL Z039.11118 / ROUND Z039.10118
NOTES	Use standard fittings where not supplied <b>Remove standard gasket if fitted.</b>	FEATURES	

CONTINUED FROM OVERLEAF:

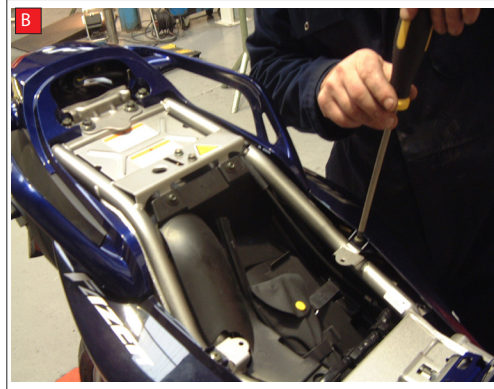

A) Remove seat

B) Remove side panels

C) Remove Tail section

D) Remove Tail section

E) Remove Tail section

F) Disconnect rear light

G) Remove number plate mounting bracket



H) Remove number plate mounting bracket

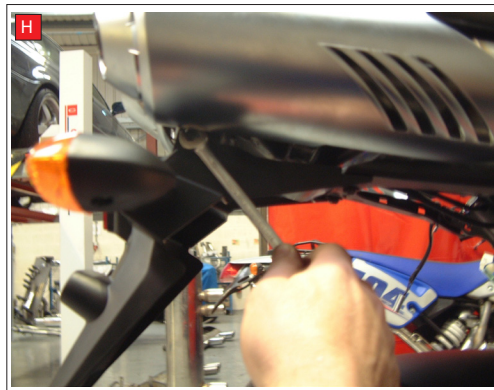
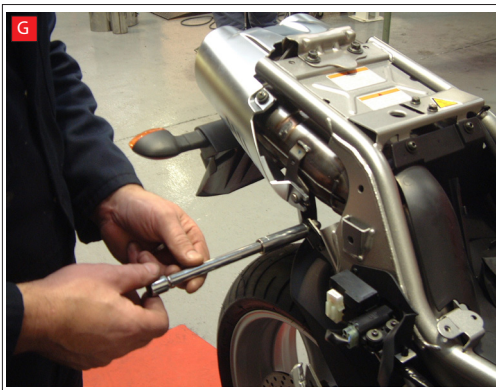
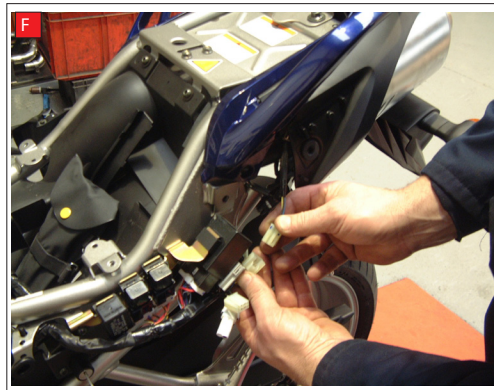

BIKE	Yamaha FZ6 / FZS600 Fazer	PART NO.	EYA-70
YEAR	2004-06	FIT KITS	OVAL Z039.11118 / ROUND Z039.10118
NOTES	Use standard fittings where not supplied <b>Remove standard gasket if fitted.</b>	FEATURES	

CONTINUED FROM OVERLEAF:

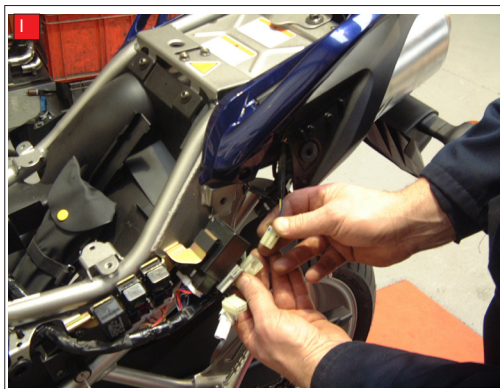

I) Disconnect indicators

J) Take off number plate mounting section

K) Loosen exhaust clamp

L) Remove Exhaust mounting bolts

M) Remove original Exhaust system

N) Loosely attach Scorpion mounting bracket

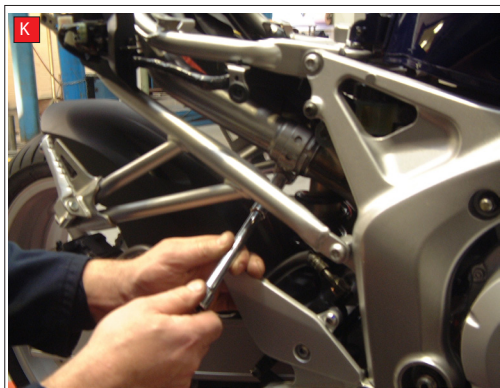

O) Slide in Scorpion connecting pipe

P) Loosely fit Scorpion silencers

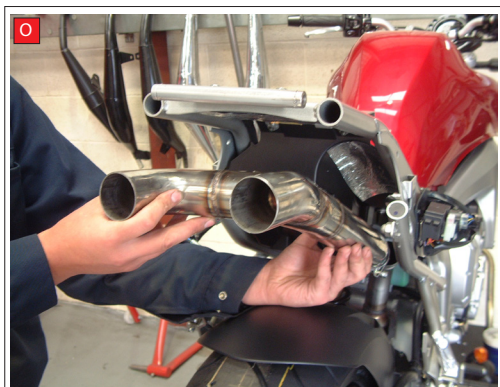

Box: PLOCK 2

BIKE	Yamaha FZ6 / FZS600 Fazer	PART NO.	EYA-70
YEAR	2004-06	FIT KITS	OVAL Z039.11118 / ROUND Z039.10118
NOTES	Use standard fittings where not supplied <b>Remove standard gasket if fitted.</b>	FEATURES	

CONTINUED FROM OVERLEAF:



Q) Fit Scorpion silencer straps



R) Align Scorpion silencers to suit bike

S) Tighten Scorpion band clamps

T) Fit Scorpion number plate mounting bracket

U) Fit Scorpion bracket loosely in number plate mount



V) Re-fit number plate mounting unit attaching the bracing arm to both Scorpion brackets.

Plug indicators back in original sockets and ensure wires are clear of Scorpion silencer cans, tighten all mounting bolts and fit side panels and seat (Ensure all standard functions work correctly and system is secure)

